

REVISIONS		
ZONE	REV	DESCRIPTION
		DATE
		APPROVED

SYSTEM CURRENT DRAW SHOULD NOT EXCEED 80% OF THE TOTAL CURRENT RATING OF THE POWER SUPPLY. SEE DIAGRAM 15 FOR CURRENT RATING OF INDIVIDUAL UNITS .

△ CABLING NOTES SEE PAGE 14 FOR DETAILS

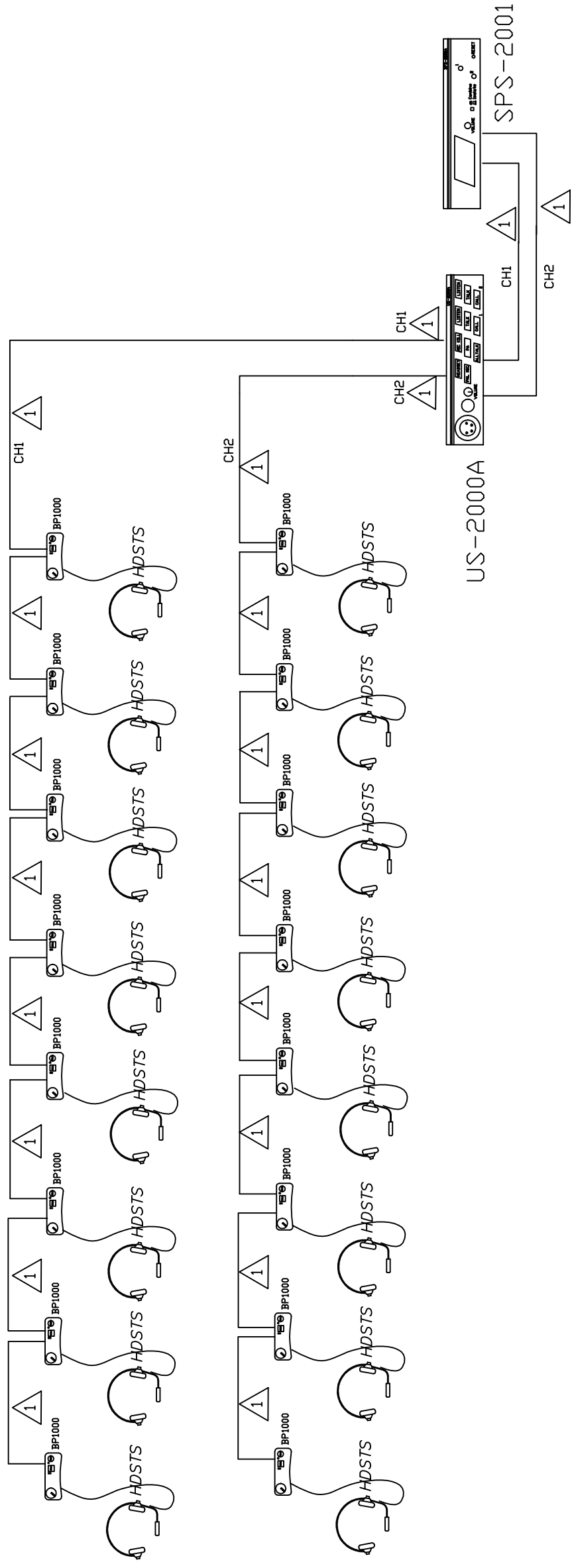

TELEX COMMUNICATIONS INC.
12000 PORTLAND AVE. SOUTH
BURNSVILLE ,MN 55337

2 CH MASTER STATION SYSTEM

DRAWN BY	S ANDERSON	SIZE	FSCM NO.	DWG NO.	REV
		A		SYS_AUDIOCOMM_DIA_4	A
SCALE	N/A			SHEET 4	OF 15

SYSTEM CURRENT DRAW SHOULD NOT EXCEED 80% OF THE TOTAL CURRENT RATING OF THE POWER SUPPLY. SEE DIAGRAM 15 FOR CURRENT RATING OF INDIVIDUAL UNITS .

△ CABLING NOTES SEE PAGE 14 FOR DETAILS

REVISIONS

ZONE	REV	DESCRIPTION	DATE	APPROVED

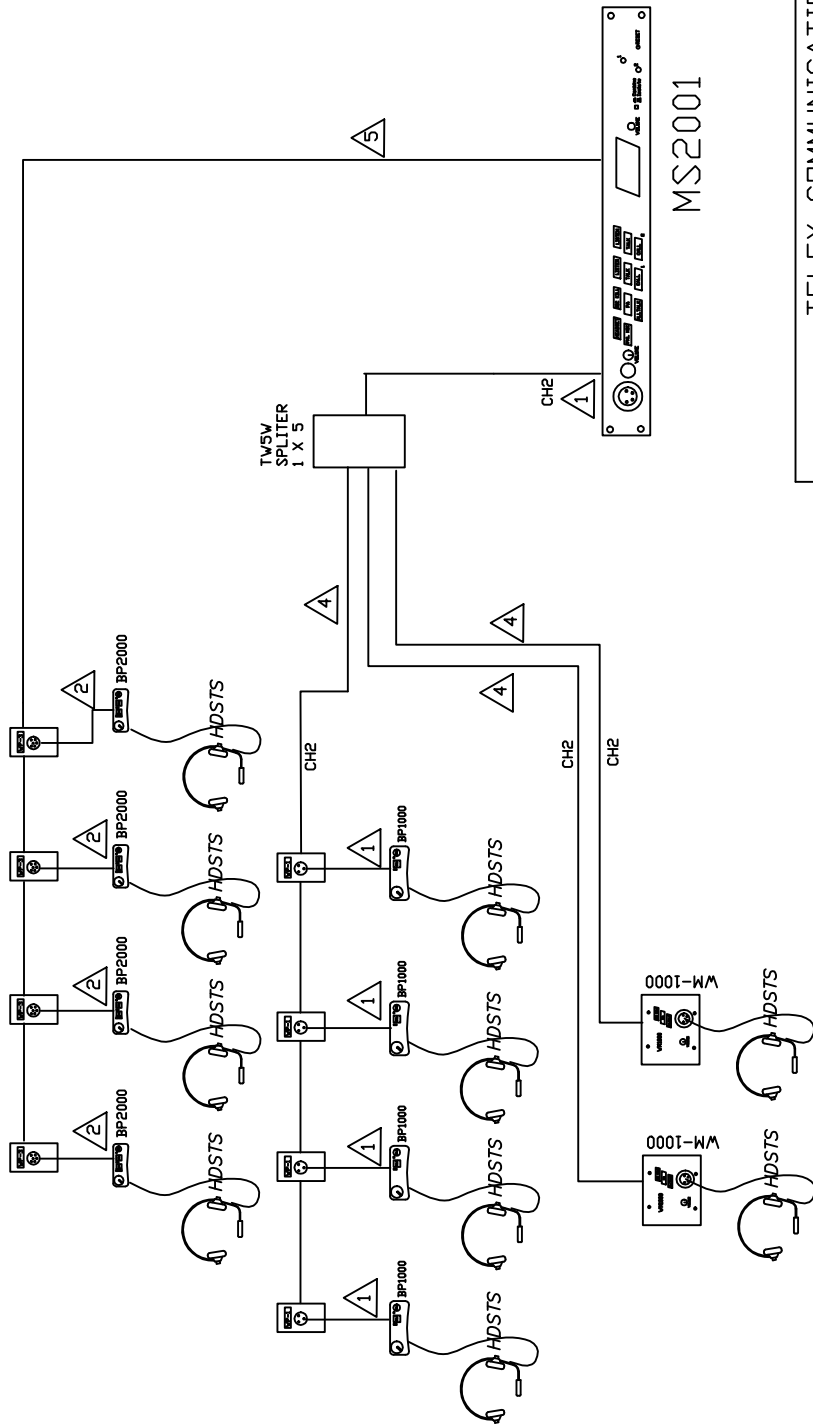

TELEX COMMUNICATIONS INC.
12000 PORTLAND AVE. SOUTH
BURNSVILLE ,MN 55337

2CH MASTER STATION
WITH MIXED USER STATIONS

DRAWN BY S ANDERSON

SIZE A

FSCM NO.

DWG NO. SYS_AUDIOCOMM_DIA_5

REV A

SCALE N/A

SHEET 5 OF 15

SYSTEM CURRENT DRAW SHOULD NOT EXCEED 80% OF THE TOTAL CURRENT RATING OF THE POWER SUPPLY. SEE DIAGRAM 15 FOR CURRENT RATING OF INDIVIDUAL UNITS.
 ▲ CABLING NOTES SEE PAGE 14 FOR DETAILS

REVISIONS				
ZONE	REV	DESCRIPTION	DATE	APPROVED

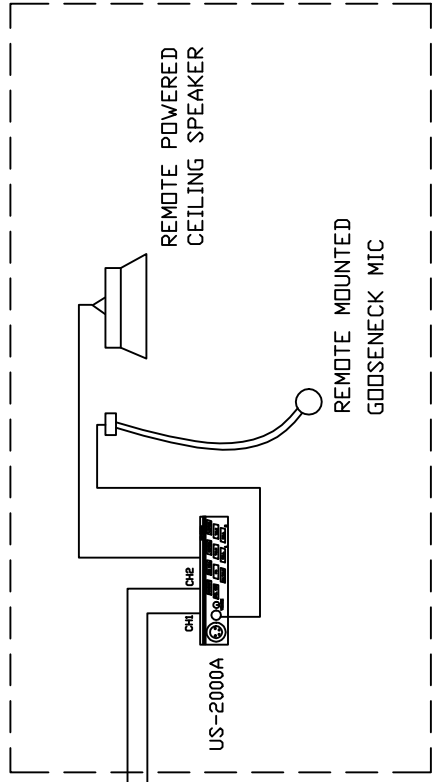

ISOLATED LAB

TELEX COMMUNICATIONS INC. 12000 PORTLAND AVE. SOUTH BURNSVILLE, MN 55337		US2000 A CATHODE LAB SYSTEM	
DRAWN BY	S ANDERSON	SIZE	A
		FSCM NO.	SYS_AUDI0COMM_DIA_6
		DWG NO.	A
		SCALE	N/A
			SHEET 6 OF 15

SYSTEM CURRENT DRAW SHOULD NOT EXCEED 80% OF THE TOTAL CURRENT RATING OF THE POWER SUPPLY. SEE DIAGRAM 15 FOR CURRENT RATING OF INDIVIDUAL UNITS .

△ CABLING NOTES SEE PAGE 14 FOR DETAILS

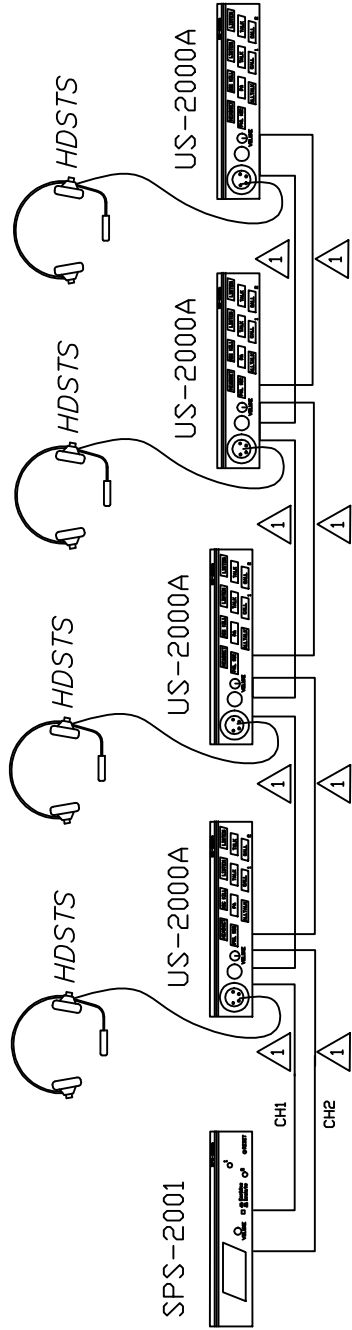

REVISIONS

ZONE	REV	DESCRIPTION	DATE	APPROVED

TELEX COMMUNICATIONS, INC.
12000 PORTLAND AVE. SOUTH
BURNSVILLE ,MN 55337

2 CH CONFERENCE SYSTEM

DRAWN BY S ANDERSON

SIZE A
FSCM NO. A

DWG NO. SYS_AUDIOCOMM_DIA_7

REV A

SCALE N/A

SHEET 7 OF 15

REVISIONS		
ZONE	REV	DATE

DESCRIPTION	DATE	APPROVED

PRODUCER US-2000A

LIGHTING DIR US-2000A

DIRECTOR

MS2001

EMS4001

TALENT IFB'S CH 3-6

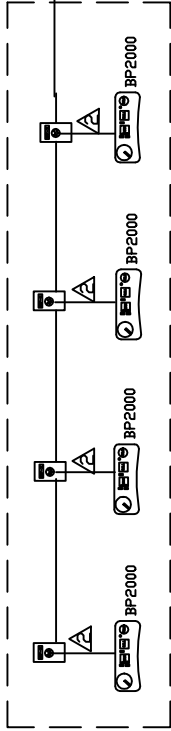

CAMERAS 1 ,2 & REVING

SYSTEM CURRENT DRAW SHOULD NOT EXCEED 80% OF THE TOTAL CURRENT RATING OF THE POWER SUPPLY. SEE DIAGRAM 15 FOR CURRENT RATING OF INDIVIDUAL UNITS .
 △ CABLING NOTES SEE PAGE 14 FOR DETAILS

TELEX COMMUNICATIONS INC. 12000 PORTLAND AVE. SOUTH BURNSVILLE ,MN 55337	
6 CH MASTER STATION SYSTEM FOR SMALL TV STUDIO OR THEATER	
DRAWN BY S ANDERSON	SIZE A
FSCH NO.	DWG NO. SYS_AUDIOCOMM_DIA_8
SCALE N/A	REV A
SHEET 8 OF 15	

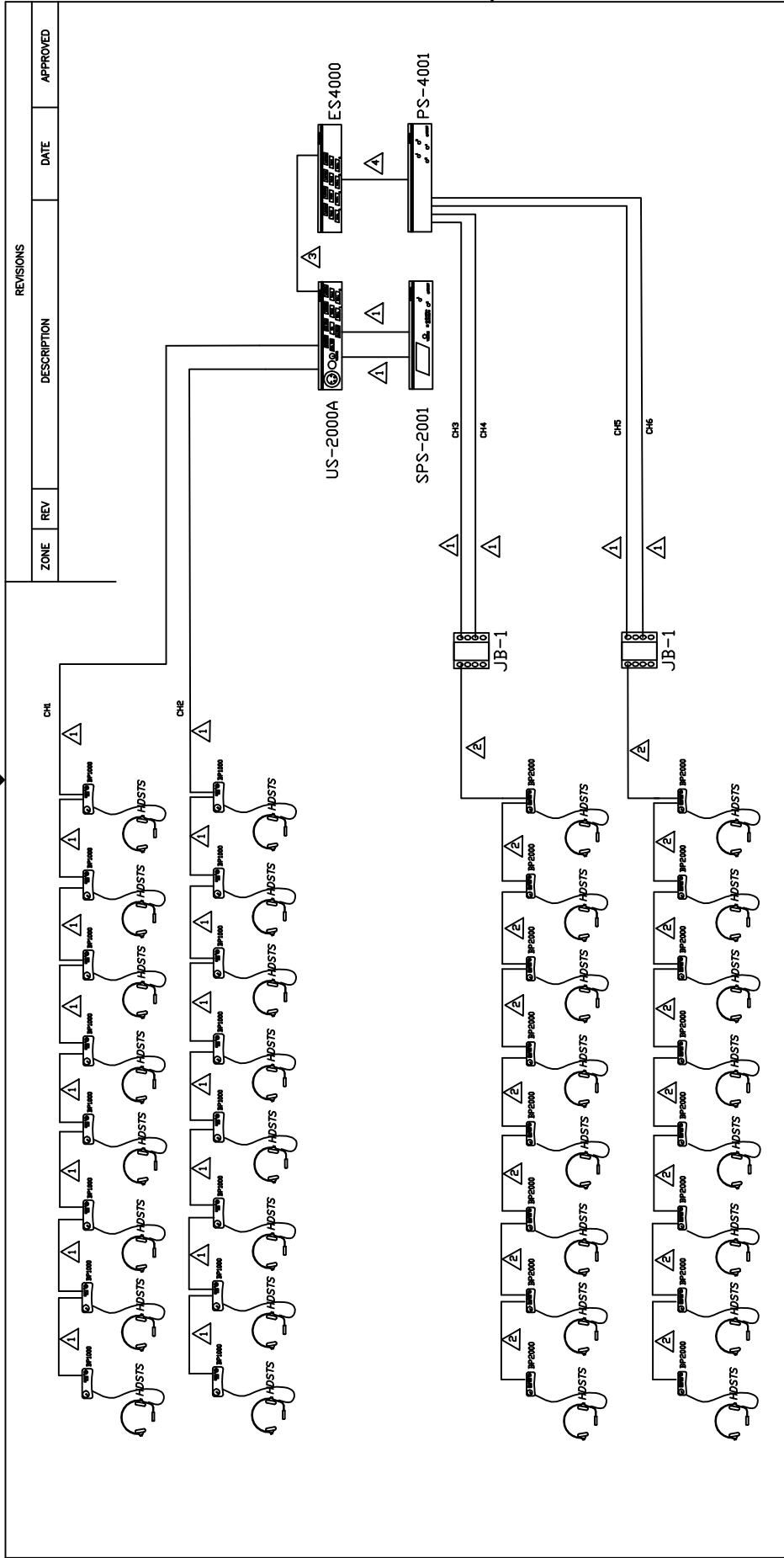

SYSTEM CURRENT DRAW SHOULD NOT EXCEED 80% OF THE TOTAL CURRENT RATING OF THE POWER SUPPLY. SEE DIAGRAM 15 FOR CURRENT RATING OF INDIVIDUAL UNITS.
 △ CABLING NOTES SEE PAGE 14 FOR DETAILS

TELEX COMMUNICATIONS INC. 12000 PORTLAND AVE. SOUTH BURNSVILLE, MN 55337	
6 CH MASTER STATION SYSTEM MIXED BP-1000 AND BP-2000	
DRAWN BY S ANDERSON	SIZE FSCM NO. A
SCALE N/A	DWG NO. SYS_AUDIOCOMM_DIA_9
	REV A
	SHEET 9 OF 15

REVISIONS		
ZONE	REV	DESCRIPTION

DATE	APPROVED

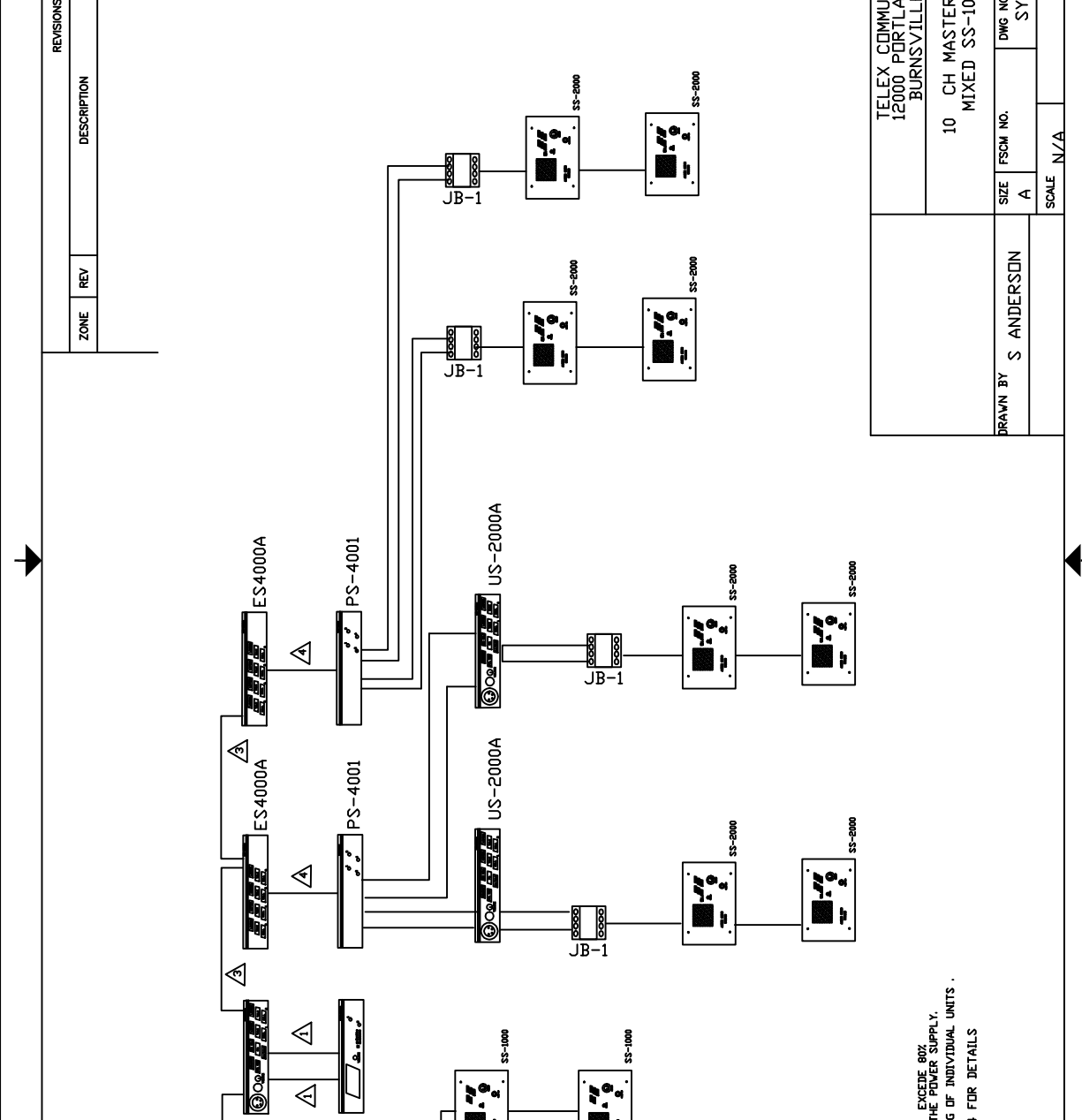

SYSTEM CURRENT DRAW SHOULD NOT EXCEED 80% OF THE TOTAL CURRENT RATING OF THE POWER SUPPLY. SEE DIAGRAM 15 FOR CURRENT RATING OF INDIVIDUAL UNITS.
 ▽ CABLING NOTES SEE PAGE 14 FOR DETAILS

TELEX COMMUNICATIONS INC. 12000 PORTLAND AVE. SOUTH BURNSVILLE, MN 55337	
10 CH MASTER STATION SYSTEM MIXED SS-1000 AND SS-2000	
DRAWN BY S ANDERSON	SIZE A
FSCH NO.	DWG NO. SYS_AUDI0COMM_DIA_12
SCALE N/A	REV A
SHEET 12 OF 17	

SHEET		REVISIONS		ECCO. NO. / REVISION / APP. DATE.	
REV.	DATE	REV.	DESCRIPTION	REV.	DATE

SHEET		REVISIONS		ECCO. NO. / REVISION / APP. DATE.	
REV.	DATE	REV.	DESCRIPTION	REV.	DATE

NOTES:

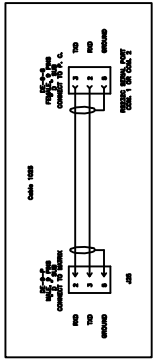
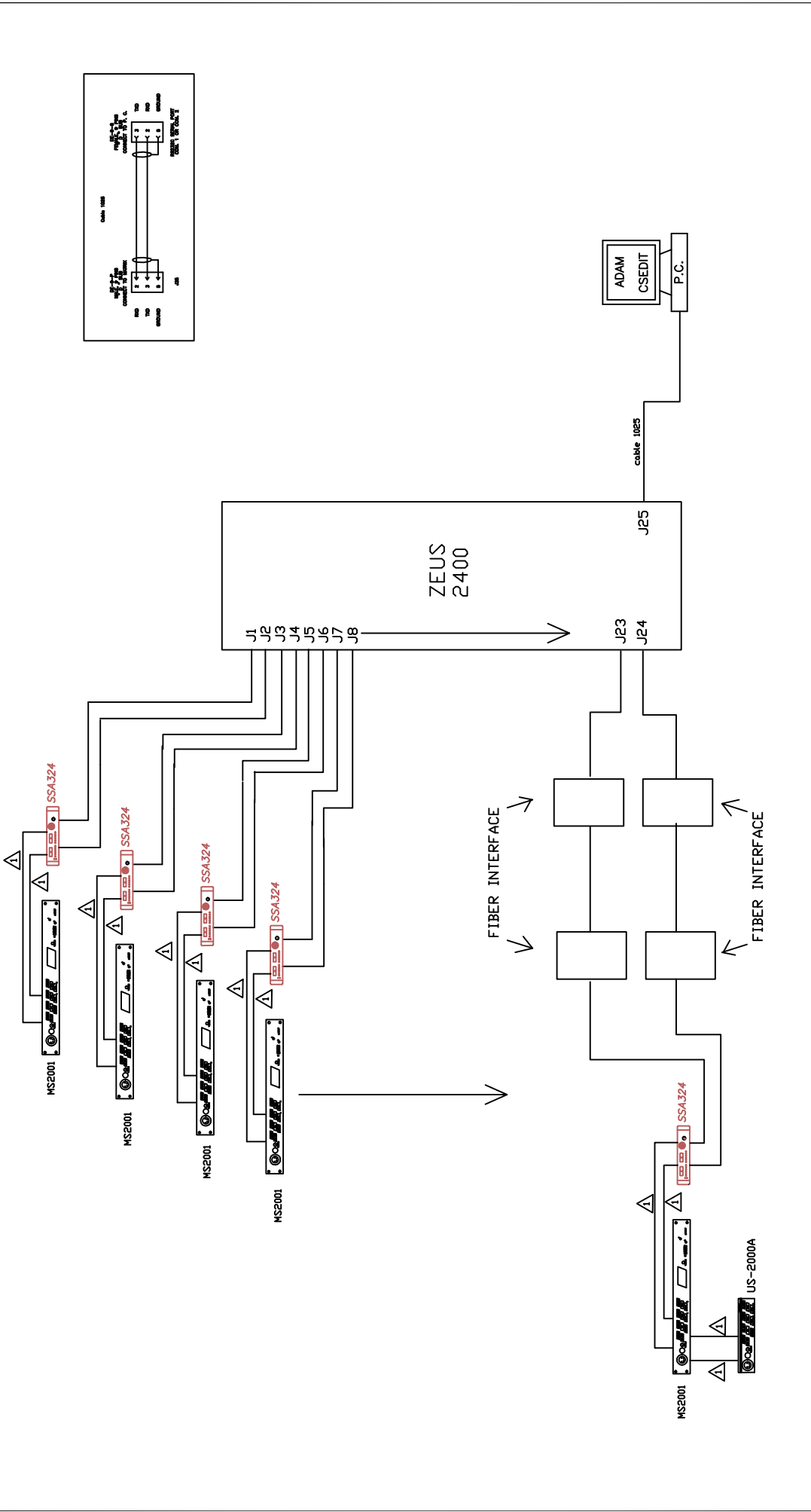

PART NUMBER		DESCRIPTION	
IR	APP	DATE	SCALE

TITLE		DESCRIPTION	
IR	APP	DATE	SCALE

UNLESS OTHERWISE SPECIFIED	

MATERIALS	

MATERIALS	

MATERIALS	

MATERIALS	

REVISIONS		
ZONE	REV	DESCRIPTION

DATE

APPROVED

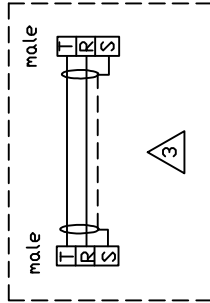
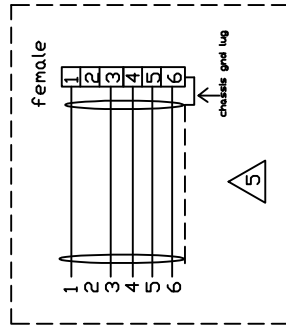
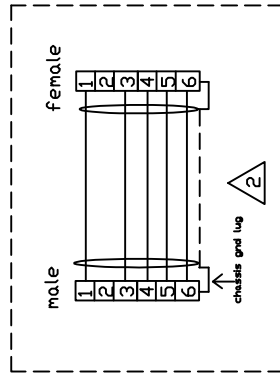
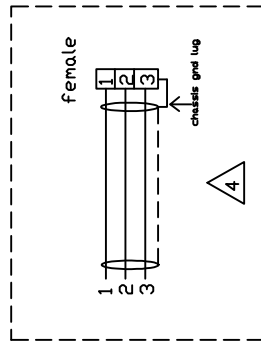
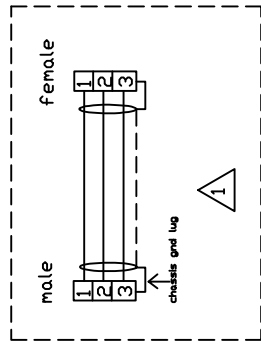

TELEX COMMUNICATIONS INC. 12000 PORTLAND AVE. SOUTH BURNSVILLE, MN 55337		CABLE DIAGRAM	
DRAWN BY	S ANDERSON	SIZE	FSCM NO.
		A	
		SCALE	N/A
		DWG NO.	SYS_AUDIOCOMM_DIA_14
		REV	A
		SHEET	14 OF 15

REVISIONS

ZONE	REV	DESCRIPTION	DATE	APPROVED
------	-----	-------------	------	----------

AUDIO COMM MODEL	CURRENT DRAW (MAX.)
BP-1000	65 mA
BP-2000	65 mA
WM-1000	65 mA
WM-2000	65 mA
SS-1000	175 mA
SS-2000	175 mA
US-2000A	150 mA
ES-4000A	150 mA
MS-2001	65 mA
EMS-4001	65 mA
JB-1	0 mA
CCB-1	12 mA
SPK-1000	150 mA
SPK-2000	150 mA
IFB-1000	60 mA

POWER SUPPLY MODEL	CURRENT OUTPUT
PS-1F	.5amps/12watts
PS-2001L	2amps/48watts
SPS-2001A	2amps/48watts
PS-4001	2amps/48watts
PS-L (DC WALL PACK)	.5amps/12watts

TELEX COMMUNICATIONS INC.
 12000 PORTLAND AVE. SOUTH
 BURNSVILLE ,MN 55337

CURRENT SPECIFICATIONS CHART

DRAWN BY S ANDERSON		SIZE A	FSCM NO.	DWG NO. SYS_AUDIOCOMM_DIA_15	REV A
		SCALE N/A			SHEET 15 OF 15